

THIS DOCUMENT IS SUBJECT TO CHANGE WITHOUT NOTICE. IT IS CONFIDENTIAL AND A PROPERTY OF Amphenol LTW. DISCLOSURE TO THIRD PARTY HAS TO BE AUTHORIZED BY Amphenol LTW.

REV.	ECN NO.	DATE	SIGN	DESCRIPTION
A		2023/12/29	Yunchen	Rev.01 to Rev.A

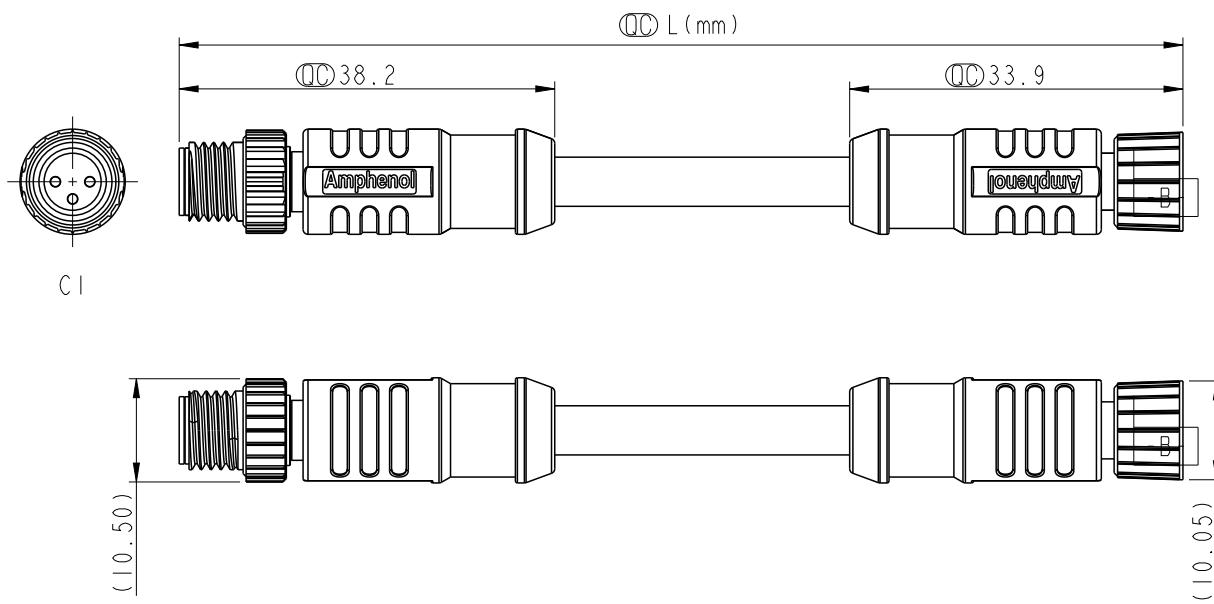



M8XXML-8FL-SBXXX
 XX: No. Of Pin
 XXX: 0.5~99Meters
 A05: 0.5 Meter
 001: 1 Meter
 002: 2 Meters
 :
 099: 99 Meters

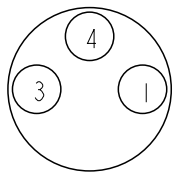
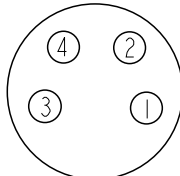
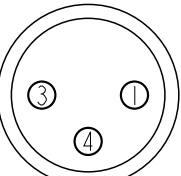
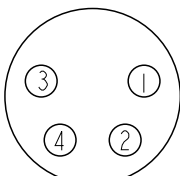

- Note:
- * RoHS Compliant
 - * \varnothing Important dimension
 - * Waterproof rate: IP67, mated
 - * C1
 Housing: Thermoplastic, Black
 Pin: Copper alloy, Gold plated
 Nut: Metal
 Outer mold: Thermoplastic, Black
 - * C2
 Housing: Thermoplastic, Black
 Pin: Copper alloy, Gold plated
 O-Ring: Rubber, Gray
 Nut: Metal
 Outer mold: Thermoplastic, Black
 - * Cable: UL20549, 22#*3C, OD=3.8mm, PUR Jacket, BK
 - * Cable length tolerance: $0.5M < L \leq 1M$: +60/-0 mm
 $1M < L \leq 3M$: +120/-0 mm
 $3M < L \leq 5M$: +160/-0 mm
 $5M < L \leq 10M$: ±100 mm
 $10M < L \leq 20M$: ±200 mm
 $20M < L \leq 30M$: ±300 mm
 $30M < L \leq 99M$: ±500 mm

UNIT: mm TOLERANCE ±0.5mm	TITLE ACC, SEN, DB-ENDED MF, 33			<h1 style="text-align: center;">Amphenol LTW</h1> <p style="text-align: center;">安費諾亮泰企業股份有限公司</p>	ITEM NO	DRAWN BY Yunchen	DATE 2023/12/29
	SCALE 1:1	SIZE A4	SHEET 1 OF 2		DWG NO M8XXML-8FL-SBXXX	CHECKED BY Neo	DATE 2023/12/29
	REV. A	WC-REV. A.2	\varnothing : Inspection item		CUSTOMER ALTW	APPROVED BY Fred	DATE 2023/12/29

THIS DOCUMENT IS SUBJECT TO CHANGE WITHOUT NOTICE. IT IS CONFIDENTIAL AND A PROPERTY OF Amphenol LTW. DISCLOSURE TO THIRD PARTY HAS TO BE AUTHORIZED BY Amphenol LTW.

F																																				
E																																				
D	Pin Out	<table style="width: 100%; border-collapse: collapse;"> <tr> <td style="text-align: center;">4</td> <td style="text-align: center;">Black</td> <td style="text-align: center;">黑</td> </tr> <tr> <td style="text-align: center;">3</td> <td style="text-align: center;">Blue</td> <td style="text-align: center;">藍</td> </tr> <tr> <td style="text-align: center;">1</td> <td style="text-align: center;">Brown</td> <td style="text-align: center;">棕</td> </tr> <tr> <td style="text-align: center;">Pin#</td> <td style="text-align: center;">Wire</td> <td></td> </tr> </table>	4	Black	黑	3	Blue	藍	1	Brown	棕	Pin#	Wire		<table style="width: 100%; border-collapse: collapse;"> <tr> <td style="text-align: center;">4</td> <td style="text-align: center;">Black</td> <td style="text-align: center;">黑</td> </tr> <tr> <td style="text-align: center;">3</td> <td style="text-align: center;">Blue</td> <td style="text-align: center;">藍</td> </tr> <tr> <td style="text-align: center;">2</td> <td style="text-align: center;">White</td> <td style="text-align: center;">白</td> </tr> <tr> <td style="text-align: center;">1</td> <td style="text-align: center;">Brown</td> <td style="text-align: center;">棕</td> </tr> <tr> <td style="text-align: center;">Pin#</td> <td style="text-align: center;">Wire</td> <td></td> </tr> </table>	4	Black	黑	3	Blue	藍	2	White	白	1	Brown	棕	Pin#	Wire							
4	Black	黑																																		
3	Blue	藍																																		
1	Brown	棕																																		
Pin#	Wire																																			
4	Black	黑																																		
3	Blue	藍																																		
2	White	白																																		
1	Brown	棕																																		
Pin#	Wire																																			
C	C2	 <p style="text-align: center;">3P</p>	 <p style="text-align: center;">4P</p>																																	
B	C1	 <p style="text-align: center;">3P</p>	 <p style="text-align: center;">4P</p>																																	
	Pin Assignment Front View																																			
A	UNIT:mm	 	TITLE ACC, SEN, DB-ENDED MF, 33	<h1 style="margin: 0;">Amphenol LTW</h1> <h2 style="margin: 0;">安費諾亮泰企業股份有限公司</h2>		ITEM NO	DRAWN BY	DATE																												
	TOLERANCE		SCALE 1:1 SIZE A4 SHEET 2 OF 2 REV. A WC-REV. .0  : Inspection item			DWG NO M8XXML-8FL-SBXXX	CHECKED BY Neo	DATE 2023/12/29																												
						CUSTOMER ALTW	APPROVED BY Fred	DATE 2023/12/29																												
								8 W10814-03-2#01A2																												