

THIS DOCUMENT IS SUBJECT TO CHANGE WITHOUT NOTICE. IT IS CONFIDENTIAL AND A PROPERTY OF Amphenol LTW. DISCLOSURE TO THIRD PARTY HAS TO BE AUTHORIZED BY Amphenol LTW.

REV.	ECN NO.	DATE	SIGN	DESCRIPTION
E	LEN1790140~51	2017-08-29	Lingpeng	Change The Note
F	N180019	2017-08-29	Lingpeng	Add 5 Pole
G	C231483	2023-11-27	Wenxiang	△G.XI

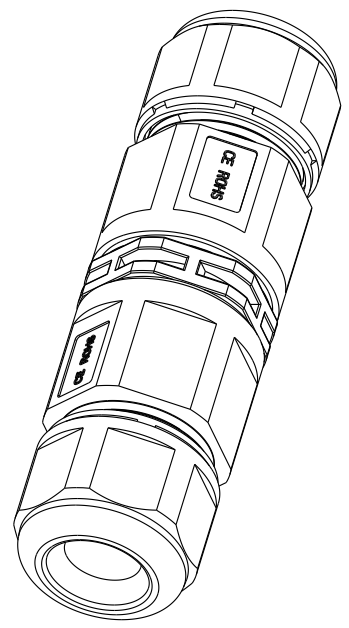
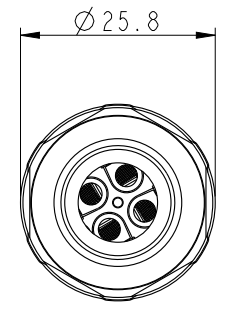
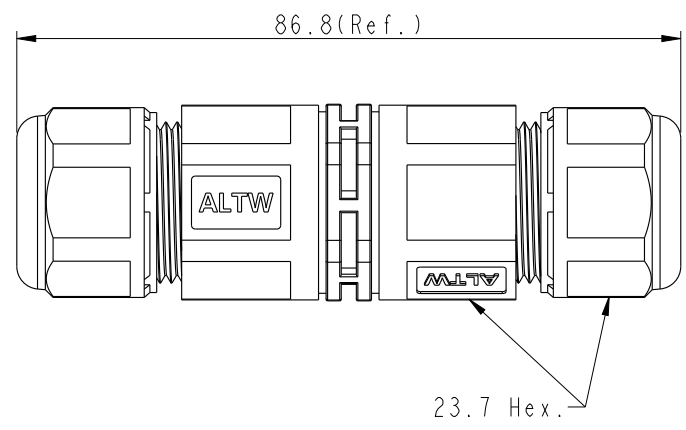
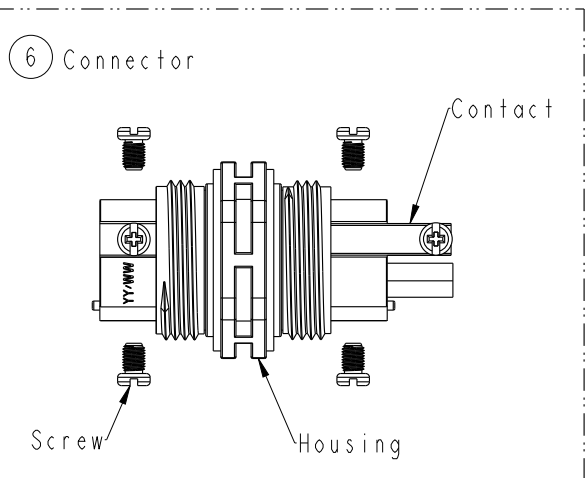
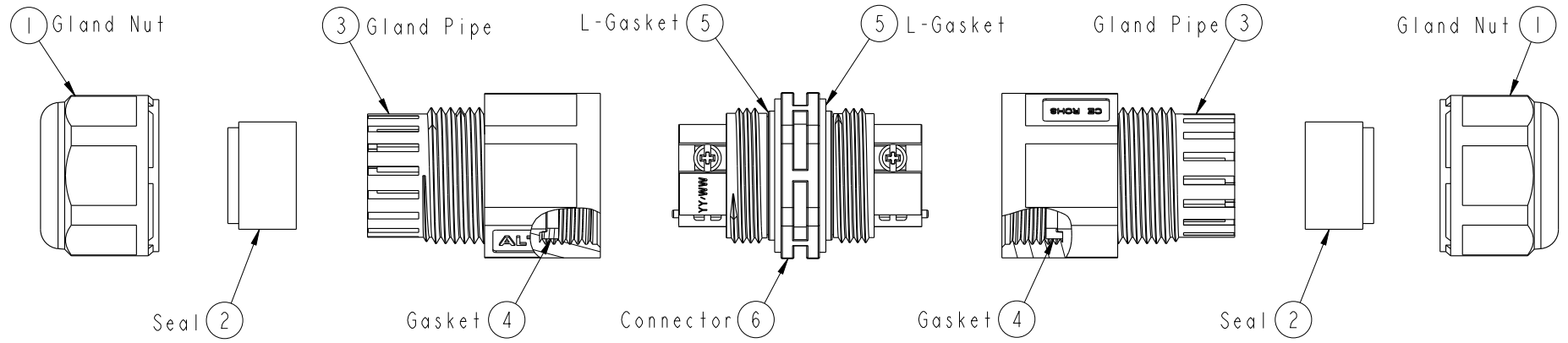

UNIT:mm		
TOLERANCE	±0.5mm	

TITLE PG11 Cable Joiner Screw-in Type		
SCALE 1:1	SIZE A4	SHEET 1 OF 2
REV. G	WC-REV. A.13	QC: Inspection item

Amphenol LTW
安費諾亮泰企業股份有限公司

ITEM NO.	DRAWN BY Lingpeng	DATE 2019-03-14
DWG NO. SC-L-PG11-XX-XX	CHECKED BY Ma Fei	DATE 2019-03-14
CUSTOMER ALTW	APPROVED BY Jerry	DATE 2019-03-14

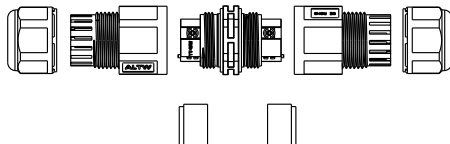
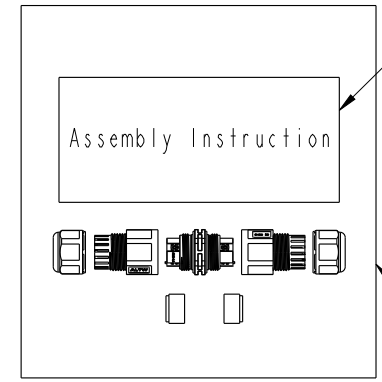
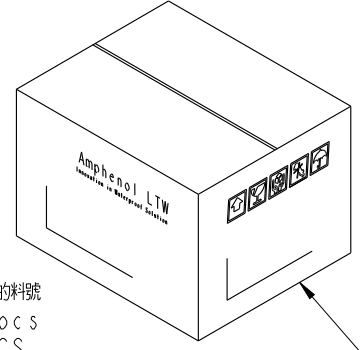
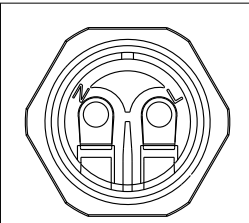
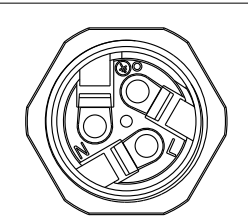
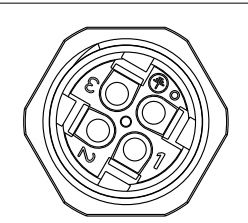
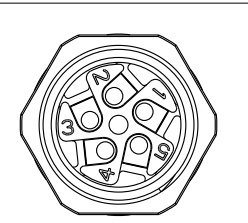
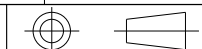
D	 <p style="text-align: center;">QTY: 1PCS</p> <p style="text-align: center;">→</p>		 <p style="text-align: center;">QTY: 120PCS</p> <p style="text-align: center;">→</p> <p style="text-align: center;">G 料號尾綴是AA的料號 實物來料為90pcs 其餘為120PCS</p>		 <p style="text-align: center;">9 Carton</p>								
E	<p style="text-align: center;">Both A Unassembled product And An Instruction Are In A PE Bag. (將一套未組裝的產品和說明書, 放置於一個PE袋, 並封口)</p>												
F	<p>SC-L-PGII-XX-XX</p> <p>L: Cable Joiner</p> <p>Type: PGII</p>		<p>Seal's Color: BL-Blue(藍色) For Cable Range: $\varnothing 4.5\sim\varnothing 6.5\text{mm}$ YW-Yellow(黃色) For Cable Range: $\varnothing 6.5\sim\varnothing 8.5\text{mm}$ GN-Green(綠色) For Cable Range: $\varnothing 8.5\sim\varnothing 10.5\text{mm}$ RD-Red(紅色) For Cable Range: $\varnothing 10.5\sim\varnothing 12.5\text{mm}$ AA-All Seals For Cable Range: $\varnothing 4.5\sim\varnothing 12.5\text{mm}$</p> <p>No. of Conductor: 02-2Poles 03-3Poles 04-4Poles 05-5Poles</p>										
C					<p>Note: E F</p> <ul style="list-style-type: none"> * Important Dimension To Check. * Waterproof Rate: IP68 (50M, 24H) * Housing: PA66+GF, Black. * Gland Nut: PA6+GF, Black. * Gland Pipe: PA66, Black. * Contact: Brass, Nickel Plated * Gasket & L-Gasket : Silicone, Yellow. * Seal: Silicone, Blue & Yellow & Green & Red. * Rated Voltage: 2~4 Pole 450V AC * Rated Current: 2 Pole Max. 30A , 3 & 4 Pole Max. 20A, 5 Pole Max. 16A * Operating Temperature: $-40^{\circ}\sim+105^{\circ}$. * Gland Pipe Recommended Tightening Torque: 8~10 Kgf.cm(0.78~0.98 N.m) * Gland Nut Recommended Tightening Torque: 8~10 Kgf.cm(0.78~0.98 N.m) * Seal For Cable OD: $\varnothing 4.5\sim\varnothing 6.5\text{mm}$, Blue. $\varnothing 6.5\sim\varnothing 8.5\text{mm}$, Yellow. $\varnothing 8.5\sim\varnothing 10.5\text{mm}$, Green . $\varnothing 10.5\sim\varnothing 12.5\text{mm}$, Red. * Screws for Wire connection recommended tightening torque: 2.00~4.50kgf.cm / 0.196~0.44 N.m * Applicable Wire gauge (Stranded wire cross section) 2~4Pole: 0.75mm^2 (18AWG) ~ 2.5mm^2 (14AWG) 5Pole: 0.5mm^2 (20AWG) ~ 1.5mm^2 (16AWG) 								
B	<p>Pole Assignments Front View</p>		 <p style="text-align: center;">2 Pole</p>		 <p style="text-align: center;">3 Pole</p>		 <p style="text-align: center;">4 Pole</p>		 <p style="text-align: center;">5 Pole</p>				
A	<p>UNIT:mm </p> <p>TOLERANCE $\pm 0.5\text{mm}$</p>		<p>TITLE PGII Cable Joiner Screw-in Type</p> <p>SCALE 1:1 SIZE A4 SHEET 2 OF 2</p> <p>REV. G WC-REV. A.13 Inspection item</p>		<h1 style="margin: 0;">Amphenol LTW</h1> <p style="margin: 0;">安費諾亮泰企業股份有限公司</p>			<p>ITEM NO</p> <p>DWG NO SC-L-PGII-XX-XX</p> <p>CUSTOMER ALTW</p>		<p>DRAWN BY Lingpeng</p> <p>CHECKED BY Ma Fei</p> <p>APPROVED BY Jerry</p>		<p>DATE 2019-03-14</p> <p>DATE 2019-03-14</p> <p>DATE 2019-03-14</p>	