

THIS DOCUMENT IS SUBJECT TO CHANGE WITHOUT NOTICE. IT IS CONFIDENTIAL AND A PROPERTY OF Amphenol LTW. DISCLOSURE TO THIRD PARTY HAS TO BE AUTHORIZED BY Amphenol LTW.

REV.	ECN NO.	DATE	SIGN	DESCRIPTION
B	C231273	2023-10-06	Ruru	$\triangle B$ X6

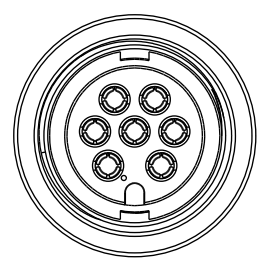
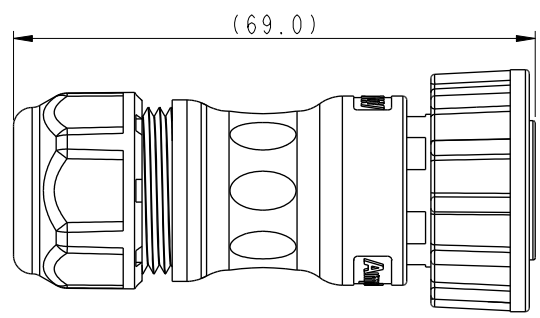
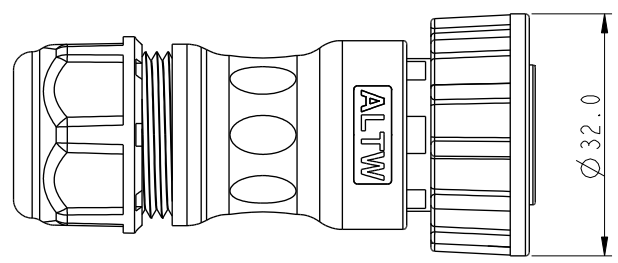
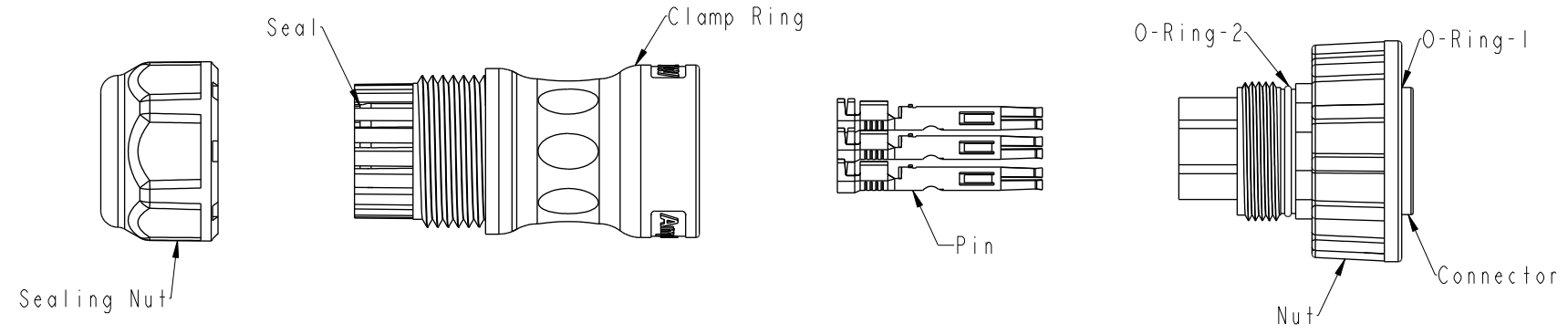

- $\triangle B$ Note:
- * RoHS Compliant
 - * $\text{\textcircled{C}}$ Important dimension
 - * Waterproof rate: IP67, mated
 - * Connector
 - Housing: Thermoplastic, Black
 - Pin: Copper alloy, Gold plated
 - Nut: Thermoplastic, Black
 - O-Ring-1: Rubber, Gray
 - O-Ring-2: Rubber, Dark gray
 - * Clamp Ring: Thermoplastic, Black
 - * Sealing Nut: Thermoplastic, Black
 - * Sealing : Rubber
 - * One set unassembled in one pe bag

UNIT:mm		
TOLERANCE		
±0.5 mm		

TITLE N CERES, ST, D-20A, CABLE W/O SR F, F, CRIMP, SCREW $\triangle B$			
SCALE 8:5	SIZE A4	SHEET 1 OF 2	
REV. B	WC-REV. A.3	$\text{\textcircled{C}}$: Inspection item	

Amphenol LTW
安費諾亮泰企業股份有限公司

ITEM NO	DRAWN BY Peng	DATE 2018-12-15
DWG NO $\triangle B$ ADC-XXBFFC-SL7XP0	CHECKED BY Mafei	DATE 2018-12-15
CUSTOMER ALTW	APPROVED BY Jerry	DATE 2018-12-15

THIS DOCUMENT IS SUBJECT TO CHANGE WITHOUT NOTICE. IT IS CONFIDENTIAL AND A PROPERTY OF Amphenol LTW. DISCLOSURE TO THIRD PARTY HAS TO BE AUTHORIZED BY Amphenol LTW.

 ADC-XXBFFC-SL7XP0

XX: No. Of Pin

- A: With Red&Yellow&Blue Color Seal
- S: With Red Color Seal, Cable OD 8.0~10.0mm.
- M: With Yellow Color Seal, Cable OD 10.0~12.0mm.
- L: With Blue Color Seal, Cable OD 12.0~14.0mm.

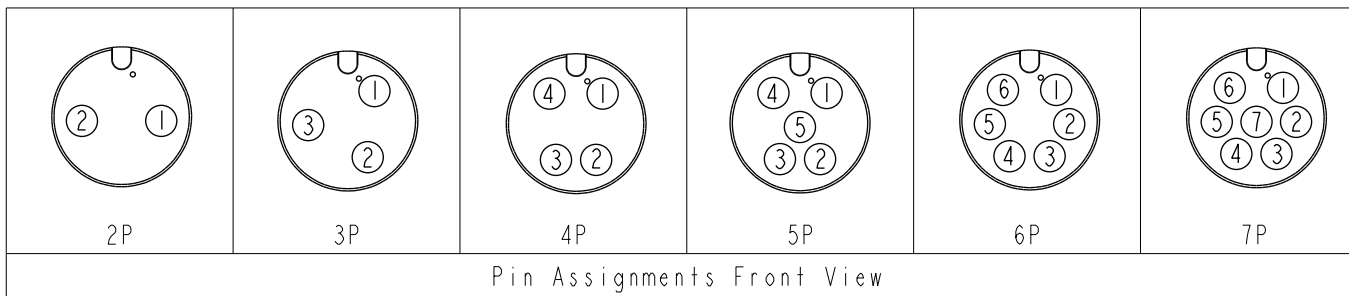

UNIT:mm
TOLERANCE

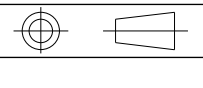

TITLE N CERES, ST, D-20A, CABLE W/O SR F, F, CRIMP, SCREW 			
SCALE 1:1	SIZE A4	SHEET 2 OF 2	
REV. B	WC-REV. .0	QC: Inspection item	

Amphenol LTW
安費諾亮泰企業股份有限公司

ITEM NO	DWG NO  ADC-XXBFFC-SL7XP0
CUSTOMER ALTW	

DRAWN BY Peng	CHECKED BY Mafei
APPROVED BY Jerry	

DATE 2018-12-15	DATE 2018-12-15
DATE 2018-12-15	