

THIS DOCUMENT IS SUBJECT TO CHANGE WITHOUT NOTICE. IT IS CONFIDENTIAL AND A PROPERTY OF Amphenol LTW. DISCLOSURE TO THIRD PARTY HAS TO BE AUTHORIZED BY Amphenol LTW.

REV.	ECN NO.	DATE	SIGN	DESCRIPTION
B	C220554	2022/04/12	Vicky	X8
C	C230186	2023/02/13	Vicky	XI

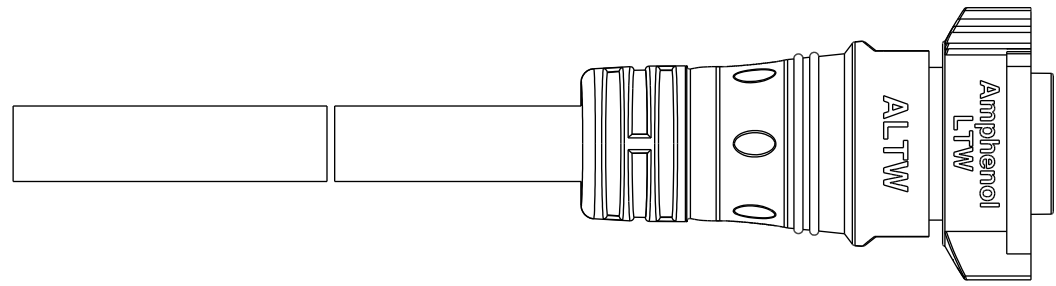

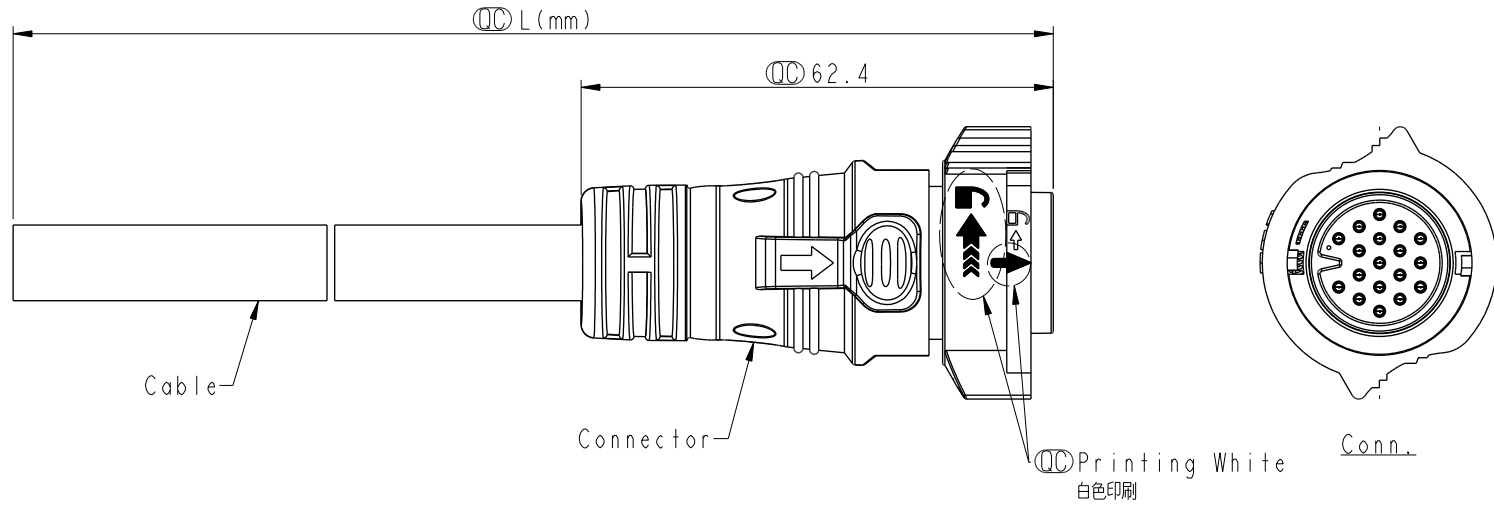

- Note:
- * RoHS Compliant
 - * Important dimension
 - * Waterproof rate: IP68, mated 1m/24h
 - * Connector
 - Housing: Thermoplastic, Black
 - Pin: Copper alloy, Gold plated
 - O-Ring: Rubber, Dark gray
 - Nut: Thermoplastic, Black
 - Outer mold: Thermoplastic, Black
 - * Cable: UL21388, PVC Jacket, Black
 - * Cable length tolerance: 1M: +50/-0 mm
 - 1M < L ≤ 3M: +100/-0 mm
 - 3M < L ≤ 5M: +150/-0 mm
 - 5M < L ≤ 10M: ±100 mm
 - 10M < L ≤ 20M: ±200 mm
 - 20M < L ≤ 30M: ±300 mm
 - 30M < L ≤ 99M: ±500 mm

UNIT: mm			TITLE XLOK, D-5A, CABLE W/SR F, M, MOLDING, PUSH LOCK	
TOLERANCE ±0.5mm	SCALE 1:1	SIZE A4	SHEET 1	OF 2
REV. C	WC-REV. A.2	: Inspection item		

Amphenol LTW
安費諾亮泰企業股份有限公司

ITEM NO	DRAWN BY Micky	DATE 2014-12-24
DWG NO DD-XXAFMM-QL8DXX	CHECKED BY Spring	DATE 2014-12-24
CUSTOMER ALTW	APPROVED BY Kevin	DATE 2014-12-24

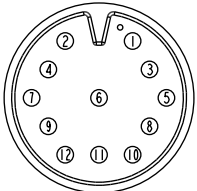
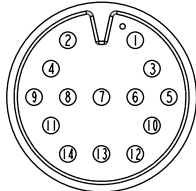
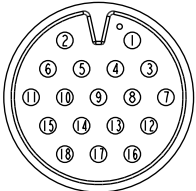
THIS DOCUMENT IS SUBJECT TO CHANGE WITHOUT NOTICE. IT IS CONFIDENTIAL AND A PROPERTY OF AMPHENOL LTW. DISCLOSURE TO THIRD PARTY HAS TO BE AUTHORIZED BY AMPHENOL LTW.

F						<table border="1" style="width: 100%; border-collapse: collapse;"> <tr> <td style="width: 25%;">18P</td> <td style="width: 25%;">10.0</td> <td rowspan="3" style="width: 25%; text-align: center;">20</td> <td style="width: 25%;">DD-18AFMM-QL8DXX</td> </tr> <tr> <td>14P</td> <td>8.5</td> <td>DD-14AFMM-QL8DXX</td> </tr> <tr> <td>12P</td> <td>8.5</td> <td>DD-12AFMM-QL8DXX</td> </tr> <tr> <td style="text-align: center;">△B</td> <td>Contacts</td> <td>Cable OD</td> <td>AWG</td> <td>Item No.</td> </tr> </table>	18P	10.0	20	DD-18AFMM-QL8DXX	14P	8.5	DD-14AFMM-QL8DXX	12P	8.5	DD-12AFMM-QL8DXX	△B	Contacts	Cable OD	AWG	Item No.		
18P	10.0	20	DD-18AFMM-QL8DXX																				
14P	8.5		DD-14AFMM-QL8DXX																				
12P	8.5		DD-12AFMM-QL8DXX																				
△B	Contacts	Cable OD	AWG	Item No.																			
E																							
D	Pin Out					<table style="width: 100%;"> <tr> <td style="text-align: center;">△B</td> <td style="text-align: center;">DD-XXAFMM-QL8DXX</td> </tr> <tr> <td style="text-align: center;">XX: No. Of Pin</td> <td style="text-align: center;">XX: 01~99Meters</td> </tr> <tr> <td></td> <td style="text-align: center;">01: 01Meter</td> </tr> <tr> <td></td> <td style="text-align: center;">02: 02Meters</td> </tr> <tr> <td></td> <td style="text-align: center;">:</td> </tr> <tr> <td></td> <td style="text-align: center;">99: 99Meters</td> </tr> </table>	△B	DD-XXAFMM-QL8DXX	XX: No. Of Pin	XX: 01~99Meters		01: 01Meter		02: 02Meters		:		99: 99Meters					
△B	DD-XXAFMM-QL8DXX																						
XX: No. Of Pin	XX: 01~99Meters																						
	01: 01Meter																						
	02: 02Meters																						
	:																						
	99: 99Meters																						
C	<table border="1" style="width: 100%; border-collapse: collapse;"> <tr> <td style="width: 33%;"> 12 Light Green 淡綠 11 Pink 粉紅 10 White 白 9 Gray 灰 8 Purple 紫 7 Blue 藍 6 Green 綠 5 Yellow 黃 4 Orange 橙 3 Red 紅 2 Brown 棕 1 Black 黑 </td> <td style="width: 33%;"> 14 Brown/White 棕/白 13 Black/White 黑/白 12 Light Green 淡綠 11 Pink 粉紅 10 White 白 9 Gray 灰 8 Purple 紫 7 Blue 藍 6 Green 綠 5 Yellow 黃 4 Orange 橙 3 Red 紅 2 Brown 棕 1 Black 黑 </td> <td style="width: 33%;"> 18 Blue/White 藍/白 17 Green/White 綠/白 16 Orange/White 橙/白 15 Red/White 紅/白 14 Brown/White 棕/白 13 Black/White 黑/白 12 Light Green 淡綠 11 Pink 粉紅 10 White 白 9 Gray 灰 8 Purple 紫 7 Blue 藍 6 Green 綠 5 Yellow 黃 4 Orange 橙 3 Red 紅 2 Brown 棕 1 Black 黑 </td> </tr> <tr> <td style="text-align: center;">Pin #</td> <td style="text-align: center;">Wire</td> <td style="text-align: center;">Wire</td> </tr> </table>	12 Light Green 淡綠 11 Pink 粉紅 10 White 白 9 Gray 灰 8 Purple 紫 7 Blue 藍 6 Green 綠 5 Yellow 黃 4 Orange 橙 3 Red 紅 2 Brown 棕 1 Black 黑	14 Brown/White 棕/白 13 Black/White 黑/白 12 Light Green 淡綠 11 Pink 粉紅 10 White 白 9 Gray 灰 8 Purple 紫 7 Blue 藍 6 Green 綠 5 Yellow 黃 4 Orange 橙 3 Red 紅 2 Brown 棕 1 Black 黑	18 Blue/White 藍/白 17 Green/White 綠/白 16 Orange/White 橙/白 15 Red/White 紅/白 14 Brown/White 棕/白 13 Black/White 黑/白 12 Light Green 淡綠 11 Pink 粉紅 10 White 白 9 Gray 灰 8 Purple 紫 7 Blue 藍 6 Green 綠 5 Yellow 黃 4 Orange 橙 3 Red 紅 2 Brown 棕 1 Black 黑	Pin #	Wire	Wire																
12 Light Green 淡綠 11 Pink 粉紅 10 White 白 9 Gray 灰 8 Purple 紫 7 Blue 藍 6 Green 綠 5 Yellow 黃 4 Orange 橙 3 Red 紅 2 Brown 棕 1 Black 黑	14 Brown/White 棕/白 13 Black/White 黑/白 12 Light Green 淡綠 11 Pink 粉紅 10 White 白 9 Gray 灰 8 Purple 紫 7 Blue 藍 6 Green 綠 5 Yellow 黃 4 Orange 橙 3 Red 紅 2 Brown 棕 1 Black 黑	18 Blue/White 藍/白 17 Green/White 綠/白 16 Orange/White 橙/白 15 Red/White 紅/白 14 Brown/White 棕/白 13 Black/White 黑/白 12 Light Green 淡綠 11 Pink 粉紅 10 White 白 9 Gray 灰 8 Purple 紫 7 Blue 藍 6 Green 綠 5 Yellow 黃 4 Orange 橙 3 Red 紅 2 Brown 棕 1 Black 黑																					
Pin #	Wire	Wire																					
B	Conn.																						
	 12P	 14P	 18P																				
	△B Pin Assignments Front View																						
A	UNIT:mm  TOLERANCE ±0.5mm	TITLE XLOK, D-5A, CABLE W/SR F, M, MOLDING, PUSH LOCK SCALE 1:1 SIZE A4 SHEET 2 OF 2 REV. C WC-REV. A.2  Inspection item	△B Amphenol LTW 安費諾亮泰企業股份有限公司	ITEM NO DWG NO DD-XXAFMM-QL8DXX △B CUSTOMER ALTW	DRAWN BY Micky CHECKED BY Spring APPROVED BY Kevin	DATE 2014-12-24 DATE 2014-12-24 DATE 2014-12-24																	
							8 W10814-03-01A2																