

REV.	DESCRIPTION
B	Change Number
C	Change PIN Number

THIS DOCUMENT IS SUBJECT TO CHANGE WITHOUT NOTICE. IT IS CONFIDENTIAL AND A PROPERTY OF Amphenol LTW. DISCLOSURE TO THIRD PARTY HAS TO BE AUTHORIZED BY Amphenol LTW.

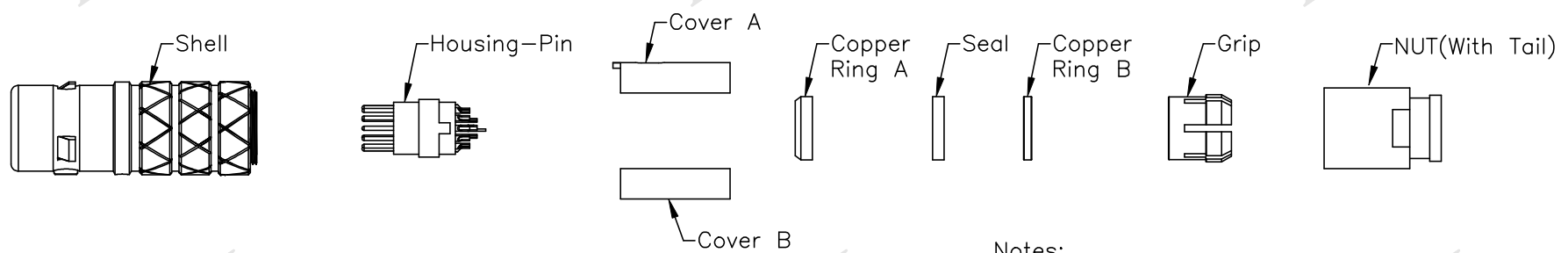

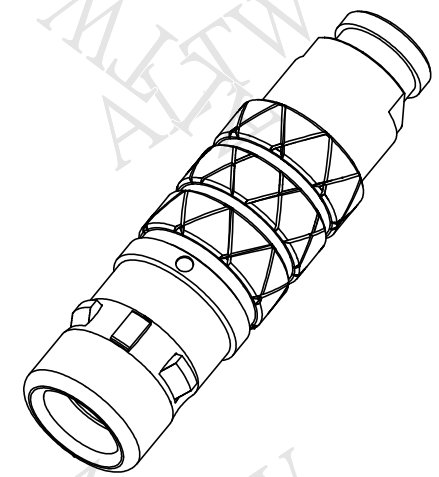

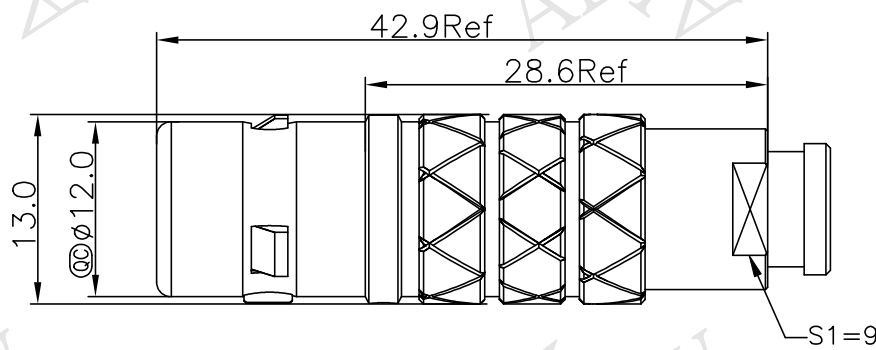







- Notes:
- \* @ø Important Dimensions To Check.
  - \* Waterproof Rate: IP68  
(Mated, by Applying O-ring and Potting Material)
  - \* Male Pin: Copper Alloy, Gold Plated.

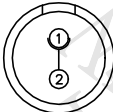
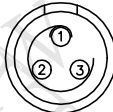
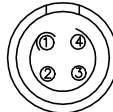
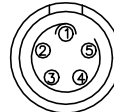

UNIT:mm TOLERANCE ±0.5MM	TITLE FLO 1K FI CONNECTOR		<b>Amphenol LTW</b> 安費諾亮泰企業股份有限公司	ITEM NO	DRAWN BY Ouyang	DATE 2019/04/26
	SCALE Free	SHEET 1 OF 2		DWG NO FLKC-XXFGMS-XCP-XXX	CHECKED BY Mafei	DATE 2019/04/26
	REV. C	SIZE A4		CUSTOMER ALTW	APPROVED BY Jerry	DATE 2019/04/26
		QC : Inspection Item				8WI0814-03-表單01A2

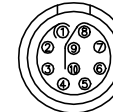
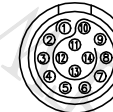
THIS DOCUMENT IS SUBJECT TO CHANGE WITHOUT NOTICE. IT IS CONFIDENTIAL AND A PROPERTY OF Amphenol LTW. DISCLOSURE TO THIRD PARTY HAS TO BE AUTHORIZED BY Amphenol LTW.

1	2	3	4	5	6	7	8				
1K-SERIES CABLE COLLET(CABLE OD)											
CABLE CLAMP SET				CABLE DIA RANGE							
TYPE		CODE ①	MAX	MIN							
FLKC-XXFGMS-XCP-XXX <span style="float: right;">△ B</span>		206	4.0	3.8							
		208	4.6	4.4							
		210	5.1	4.8							
		212	5.5	5.3							
		213	6.1	5.8							
		---	---	---							
FLKC-XXFGMS-XCP-XXX <span style="float: right;">△ B</span> _____ CABLE OD ① _____ KEY POINT ② _____ PIN CONFIGURATION ③ _____ SIZE(CONNECTOR)											
KEY POINT											
CODE ②	G	A	B	C	D						
GRAPHIC	0°	30°	45°	60°	95°						
											
PIN CONFIGURATION (Solder Definition) ③ <span style="float: right;">△ C</span>											
GRAPHIC											
	2 PIN	3 PIN	4 PIN	5 PIN	6 PIN	7 PIN	8 PIN	10 PIN	14 PIN	16 PIN	
UNIT:mm	TITLE		FLO 1K FI CONNECTOR			ITEM NO	DRAWN BY	DATE			
TOLERANCE	SCALE		SHEET			DWG NO	CHECKED BY	DATE			
±0.5MM	Free		2 OF 2			FLKC-XXFGMS-XCP-XXX	Mafei	2019/04/26			
	REV.	SIZE	QC :Inspection Item			CUSTOMER	APPROVED BY	DATE			
	C	A4				ALTW	Jerry	2019/04/26			
1	2	3	4	5	6	7	8WIOB14-03-表單01A2				

**Amphenol LTW**  
安費諾亮泰企業股份有限公司